

# Cat® 3616

## Diesel Generator Sets

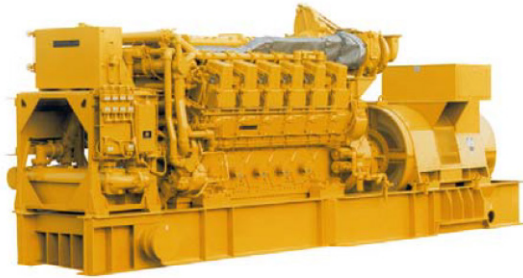

Image shown may not reflect actual configuration.

Bore – mm (in)	280 (11.0)
Stroke – mm (in)	300 (11.8)
Displacement per cylinder – L (in <sup>3</sup> )	18.5 (1127)
Total Displacement – L (in <sup>3</sup> )	296 (8,032)
Compression Ratio	13:1
Aspiration	TA
Fuel System	Direct Unit Injection

### Features

#### Cat® Diesel Engine

- Designed and optimized for low fuel consumption
- Reliable, rugged, durable design

#### Alternators

- Superior motor starting capability minimizes need for oversizing generator
- Designed to match performance and output characteristics of Cat diesel engines

#### Generator Set Package

- Fully prototype tested with certified torsional vibration analysis available

#### Worldwide Product Support

- Cat dealers have over 1,800 dealer branch stores operating in 200 countries
- Your local Cat dealer provides extensive post-sale support, including maintenance and repair agreements

#### Cat Generator Set Monitoring System (GSM)

- Simple user friendly interface and navigation
- Provides protection, monitoring, and control of the diesel generator set
- Redundant shutdown protection
- 10 inch (254 mm) color monitor to display all engine parameters and alarm annunciation
- Annunciation of all engine shutdowns, alarms, and status points
- Start/prelube control switch, fuel control switch and emergency stop buttons
- Speed control switch with automatic changing to ball head control when a governor failure occurs, if ball head control is available
- Contacts are available for customer use
- Selection of local/remote control of engine
- Selection of idle/rated control of engine
- Equipped for remote communication
- Four 4-20mA outputs (programmable)
- Relay contact signals to the remote monitoring system (summary shutdown, summary alarm, local operation/remote, engine running, PLC failure, fuel control and idle/rated)

## Standard and Optional Equipment

### Air Inlet

- Aftercooler, fresh water, corrosion resistant coated (air side)
- Air inlet shutoff
- Air cleaner
- Breather, crankcase, top-mounted
- Turbocharger, engine oil lubricated
- Soot filter
- Air cleaner louver assembly
- Vertical support bracket
- Heavy duty air cleaner
- Air inlet adapter
- Boost control valve

### Cooling

- Engine coolant water drains
- Front mounted turbos
- Three-bundle oil cooler
- Water temperature regulator
- Jacket water thermostats
- Heat exchanger for single circuit
- Heating aids
- Cooling system aids
- Auxiliary water pump
- Expansion tank

### Exhaust

- 457 mm (18 in) Cat bolt pattern
- Dry, gas tight, exhaust manifold
- Includes adapter, flexible exhaust fitting
- Flexible exhaust fittings
- Weld flange and related hardware

### Fuel

- Simplex or Duplex
- Fuel Priming Pump
- Duplex Primary Fuel Strainer
- Fuel System Connections

### Generator

- Custom generator
- 3 Phase, six leads, WYE
- Class F insulation
- Busbar connections
- Winding temperature detectors
- Anti-condensation space heaters

### Governor

- UG Actuator
- Electronic / actuators
- Digital programmers
- Battery backup / power supply
- 230 UA
- 723 Plus
- EGB Actuator

### Lube

- Centrifugal oil filters with single shutoff
- Service side engine mounted on cylinder block inspection covers
- Wet oil sump. Includes engine-driven main lubrication pump, installed oil lines, engine-driven oil pump and oil pan
- Oil filler and dipstick
- Valve, oil pressure regulating
- Valves, crankcase explosion relief
- Oil pan drain valve
- Lube ANSI adapter (emergency connection)

### Mounting

- Damper, torsional vibration
- Engine and generator mounting
- Isolator
- Spring type vibration isolator
- Vertically restrained
- Non-vertically restrained

### Starting / Charging

- Vane type air starter
- Two motors, engine mounted at rear, on left side
- Includes air silencer
- Line group for single point custom connection
- Pressure reducing valve
- Compressed air flex hose
- Turbine type air starters
- Redundant air starters

### General

- Paint, Caterpillar yellow
- Pumps, gear driven: fuel, oil, jacket water, aftercooler / oil cooler water
- Custom paint colors

## Package Performance

Performance – 1000 rpm	Notes	Standby	Prime	Continuous
Frequency		50 Hz	50 Hz	50 Hz
Engine power – bkW	(2)	5960	5420	4920
Generator power – ekW	(2)	5720	5200	4700
Performance number		DM5538-01	DM5540-01	DM5413-06
<b>Engine Data</b>				
Fuel consumption (ISO 3046/1) – g/bkW-hr	(1)	192.9	192.7	193.7
Fuel consumption (nominal) – g/bkW-hr	(1)	196.7	196.5	197.5
Fuel Consumption (90% confidence) – g/bkW-hr	(1)	198.9	198.7	199.8
Air flow (@ 25°C, 101.3 kPa) – m <sup>3</sup> /min		580.9	522.5	467.6
Air mass flow – kg/hr		38882	34971	31298
Compressor outlet pressure – kPa (abs)		307.3	266.3	227.5
Compressor outlet temperature – °C		203.0	186.5	170.2
Inlet manifold pressure – kPa (abs)		305.0	264.1	225.4
Inlet Manifold temperature – °C		60.3	59.4	58.5
Timing – °BTDC	(10)	16.5	16.5	16.5
Exhaust stack temperature – °C		395.1	404.5	420.5
Exhaust gas flow (@ stack temperature, 101.3 kPa) m <sup>3</sup> /min		1263.2	1152.5	1056.4
Exhaust gas mass flow – kg/hr		40063	36043	32277
<b>Energy Balance Data (nominal)</b>				
Fuel input energy (LHV) – kW	(1)	10401	12747	11634
Heat rejection to jacket water – kW	(4)	1166	1080	1005
Heat rejection to atmosphere – kW	(5)	281	255	233
Heat rejection to oil cooler – kW	(6)	523	569	545
Heat rejection to exhaust (LHV to 25°C) – kW	(4)	4431	4089	3820
Heat rejection to exhaust (LHV to 177°C) – kW	(4)	3087	2732	2384
Heat rejection to aftercooler – kW	(7), (8)	1537	1231	970
<b>Emissions</b>				
NO <sub>x</sub> – g/bkW-hr	(9)	12.94	13.69	14.09
CO – g/bkW-hr	(3)	0.81	0.70	0.64
HC – g/bkW-hr	(3)	0.90	0.91	0.90
PM – g/bkW-hr	(9)	0.13	0.13	0.13

### Notes

- 1) Fuel consumption tolerance. ISO 3046/1 is 0, + 5% of full load data. Nominal is ± 3% of full load data.
- 2) Engine power tolerance is ± 3% of full load data.
- 3) Emission data shown are not to exceed values.
- 4) Heat rejection to jacket water and exhaust tolerance is ± 10% of full load data. (Heat rate based on treated water.)
- 5) Heat rejection to atmosphere tolerance is ± 50% of full load data. (Heat rate based on treated water.)
- 6) Heat rejection to lube oil tolerance is ± 20% of full load data. (Heat rate based on treated water.)
- 7) Heat rejection to aftercooler tolerance is ± 5% of full load data. (Heat rate based on treated water.)
- 8) Total aftercooler heat = aftercooler heat x ACHRF. (Heat rate based on treated water.)
- 9) Emission data shown are dry and nominal values.
- 10) Timing based on AFM injectors.

## Weights and Dimensions

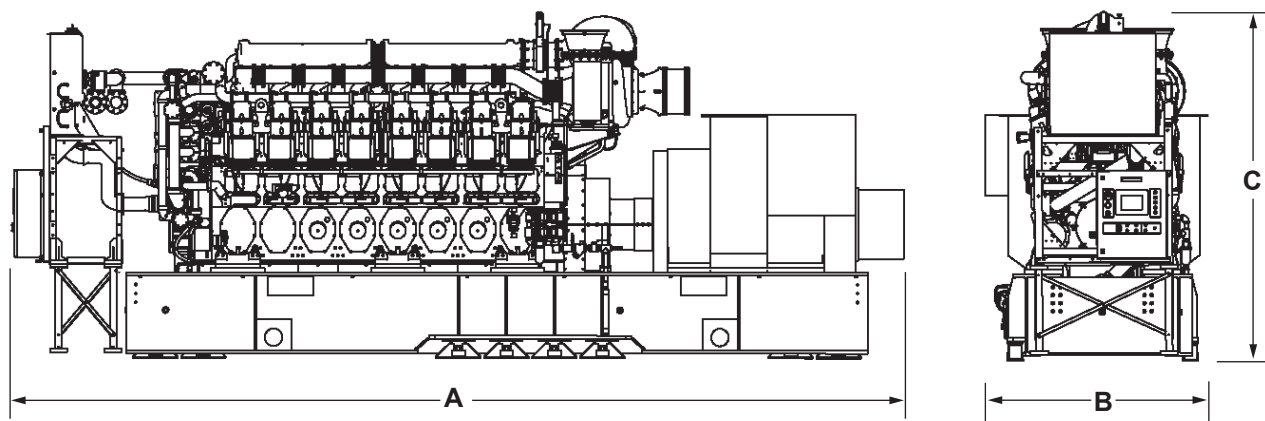

Dim "A" mm (in)	Dim "B" mm (in)	Dim "C" mm (in)	Weight kg (lb)
10261.7 (404.0)	2530.3 (99.6)	3977.7 (156.6)	51 230 (112,690)

**Note:** For reference only. Do not use for installation design. Contact your local Cat dealer for precise weights and dimensions.

## Ratings and Definitions

### Standby

Output available with varying load for the duration of the interruption of the normal source power. Average power output is 70% of the standby rated kW. Typical operation is 200 hours per year, with maximum expected usage of 500 hours per year.

### Prime

Output available with varying load for an unlimited time. Average power output is 70% of the prime rated kW. Typical peak demand is 100% of prime rated kW with 10% overload capability for emergency use for a maximum of 1 hour in 12. Overload operation cannot exceed 25 hours per year.

### Continuous

Output available with non-varying load for an unlimited time. Average power output is 70-100% of the continuous rated kW. Typical peak demand is 100% of continuous rated kW for 100% of the operating hours.

### Applicable Codes and Standards

AS 1359, CSA, IEC 60034-1, ISO 3046, ISO 8528, NEMA MG 1-22, NEMA MG 1-33, UL508A, 2014/35/EU, 2006/42/EC, 2014/30/EU.

**Note:** Codes may not be available in all model configurations. Please consult your local Cat dealer for availability.

**Engine Rating** obtained and presented in accordance with ISO 3046/1 and SAE J1995 JAN90 standard reference conditions of 25°C, 100 kPa, 30% relative humidity and 150m altitude at the stated aftercooler water temperature. Consult altitude curves for applications above maximum rated altitude and/or temperatures.

**Ratings** are based on SAE J1349 standard conditions. These ratings also apply at ISO 3046 standard conditions.

**Fuel Rates** are based on fuel oil of 35° API [16°C (60°F)] gravity having an LHV of 42 780 kJ/kg (18,390 Btu/lb) when used at 15°C (59°F) and weighing 850 g/liter (7.0936 lbs/U.S. gal). Additional ratings may be available for specific customer requirements, also, for information regarding low sulfur fuel and biodiesel capability, please consult your Cat dealer.

[www.cat.com/electricpower](http://www.cat.com/electricpower)

©2021 Caterpillar  
All rights reserved.

Materials and specifications are subject to change without notice.

The International System of Units (SI) is used in this publication. CAT, CATERPILLAR, LET'S DO THE WORK, their respective logos, "Caterpillar Corporate Yellow" the "Power Edge" and Cat "Modern Hex" trade dress as well as corporate and product identity used herein, are trademarks of Caterpillar and may not be used without permission.